

S-CUT

Solid Carbide End Mill for SUS.

2날 플랫 엔드밀

2F Flat Endmill

4날 플랫 엔드밀

4F Flat Endmill

6날 플랫 엔드밀

6F Flat Endmill

4날 볼 엔드밀

4F Ball Endmill

4날 코너R 엔드밀

4F Corner R Endmill

3-5날 라핑 엔드밀

3-5F Roughing Endmill

SUS
S-CUT

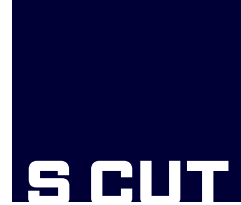

2날 스테인리스 플랫 엔드밀

2F Flat Endmill for SUS

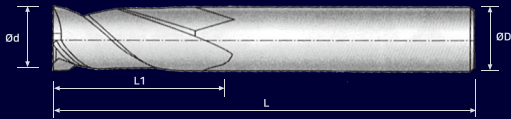
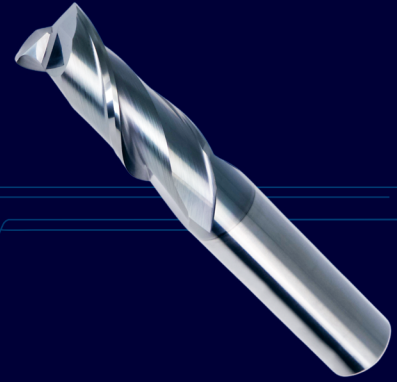

NO	CODE NO	규격 (Standard)	외경(Ød)	날장(L1)	상크(ØD)	총기장(L)
1	KW106487	Ø1*2.5L*Ø6*50L*2F	1	2.5	6	50
2	KW106488	Ø1.2*3L*Ø6*50L*2F	1.2	3	6	50
3	KW106489	Ø1.5*4L*Ø6*50L*2F	1.5	4	6	50
4	KW106490	Ø2*6L*Ø6*50L*2F	2	6	6	50
5	KW106491	Ø2.5*7L*Ø6*50L*2F	2.5	7	6	50
6	KW106492	Ø3*8L*Ø6*55L*2F	3	8	6	55
7	KW106493	Ø4*10L*Ø6*55L*2F	4	10	6	55
8	KW106494	Ø5*15L*Ø6*55L*2F	5	15	6	55
9	KW106495	Ø6*15L*Ø6*60L*2F	6	15	6	60
10	KW106496	Ø8*20L*Ø8*70L*2F	8	20	8	70
11	KW106497	Ø10*25L*Ø10*75L*2F	10	25	10	75
12	KW106498	Ø12*30L*Ø12*80L*2F	12	30	12	80
13	KW106499	Ø14*35L*Ø16*90L*2F	14	35	16	90
14	KW106500	Ø16*42L*Ø16*100L*2F	16	42	16	100
15	KW106501	Ø18*45L*Ø16*100L*2F	18	45		
16	KW106502	Ø20*48L*Ø20*100L*2F	20	48	20	100

- AL용
A-CUT
- 강용
P-CUT
- 강용
PRE-CUT
- 강용
H-CUT
- 강용
HR-CUT
- SUS
S-CUT
- 센터밀엔드밀
C-CUT
- NC드릴
NC-DRILL

4날 스테인리스 플랫 엔드밀

4F Flat Endmill for SUS



NO	CODE NO	규격 (Standard)	외경(Ød)	날장(L1)	상크(ØD)	총가장(L)
1	KW106445	Ø1*2.5L*Ø6*50L*4F	1	2.5	6	50
2	KW106446	Ø1.2*3L*Ø6*50L*4F	1.2	3	6	50
3	KW106447	Ø1.5*4L*Ø6*50L*4F	1.5	4	6	50
4	KW106448	Ø2*6L*Ø6*50L*4F	2	6	6	50
5	KW106449	Ø2.5*7L*Ø6*50L*4F	2.5	7	6	50
6	KW106450	Ø3*8L*Ø6*55L*4F	3	8	6	55
7	KW106451	Ø3*10L*Ø6*60L*4F		10		60
8	KW106452	Ø3.5*10L*Ø6*55L*4F	3.5	10	6	55
9	KW106453	Ø4*10L*Ø6*55L*4F	4	10	6	55
10	KW106454	Ø4*12L*Ø6*60L*4F		12		60
11	KW106455	Ø4.5*12L*Ø6*55L*4F	4.5	12	6	55
12	KW106456	Ø5*15L*Ø6*55L*4F	5	15	6	55
13	KW106457	Ø5.5*15L*Ø6*60L*4F	5.5	15	6	60
14	KW106458	Ø6*15L*Ø6*60L*4F	6	15	6	60
15	KW106459	Ø6*20L*Ø6*65L*4F		20		65
16	KW106460	Ø6.5*15L*Ø8*60L*4F	6.5	15	8	60
17	KW106461	Ø7*20L*Ø8*80L*4F	7	20	8	80
18	KW106462	Ø8*20L*Ø8*70L*4F	8	20	8	70
19	KW106463	Ø8*25L*Ø8*70L*4F		25		70
20	KW106464	Ø8*30L*Ø8*80L*4F		30		80
21	KW106465	Ø8.5*20L*Ø10*70L*4F	8.5	20	10	70
22	KW106466	Ø9*25L*Ø10*80L*4F	9	25	10	80
23	KW106467	Ø10*25L*Ø10*75L*4F	10	25	10	75
24	KW106468	Ø10*35L*Ø10*85L*4F		35		85
25	KW106469	Ø12*30L*Ø12*80L*4F	12	30	12	80
26	KW106470	Ø12*40L*Ø12*90L*4F		40		90
27	KW106471	Ø14*35L*Ø16*90L*4F	14	35	16	90
28	KW106472	Ø16*42L*Ø16*100L*4F	16	42	16	100
29	KW106473	Ø20*48L*Ø20*100L*4F	20	48	20	100

A-CUT
AL용

P-CUT
강용

PR-CUT
리브

H-CUT
고경도용

HR-CUT
리브

S-CUT
SUS

C-CUT
센터링엔드밀

NC-DRILL
드릴



S-CUT

6날 스테인리스 플랫 엔드밀

6F Flat Endmill for SUS

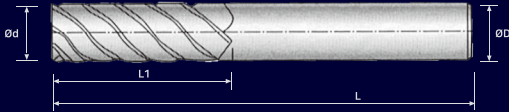

NO	CODE NO	규격 (Standard)	외경(Ød)	날장(L1)	상크(ØD)	총기장(L)
1	KW106504	Ø6 * 15L * Ø6 * 60L * 6F	6	15	6	60
2	KW106505	Ø8 * 20L * Ø8 * 70L * 6F	8	20	8	70
3	KW106506	Ø10 * 25L * Ø10 * 75L * 6F	10	25	10	75
4	KW106507	Ø12 * 30L * Ø12 * 80L * 6F	12	30	12	80
5	KW106508	Ø16 * 42L * Ø16 * 100L * 6F	16	42	16	100
6	KW106509	Ø20 * 48L * Ø20 * 100L * 6F	20	48	20	100

ALUM
A-CUT

강철
P-CUT

강철 용
PRE-CUT

강철 용
H-CUT

강철 용
HR-CUT

SUS
S-CUT

센터링엔드밀
C-CUT

NC드릴
NC-DRILL

4날 스테인리스 볼 엔드밀

4F Ball Endmill for SUS

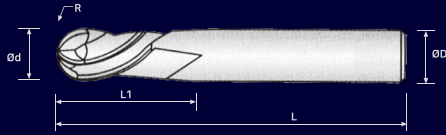

NO	CODE NO	규격 (Standard)	볼(R)	외경(Ød)	날장(L1)	상크(ØD)	총가장(L)
1	KW106477	R1.5*Ø3*8L*Ø6*60L*4F	R1.5	3	8	6	60
2	KW106478	R2*Ø4*8L*Ø6*70L*4F	R2	4			70
3	KW106479	R2.5*Ø5*12L*Ø6*80L*4F	R2.5	5	12	6	80
4	KW106480	R3*Ø6*12L*Ø6*90L*4F	R3	6			90
5	KW106481	R4*Ø8*16L*Ø8*100L*4F	R4	8	16	8	100
6	KW106482	R5*Ø10*20L*Ø10*100L*4F	R5	10	20		
7	KW106483	R6*Ø12*25L*Ø12*100L*4F	R6	12	25	12	
8	KW106484	R8*Ø16*30L*Ø16*100L*4F	R8	16	30	16	
9	KW106485	R10*Ø20*38L*Ø20*100L*4F	R10	20	38	20	

AL용
A-CUT

강용
P-CUT

강용 리브
PR-CUT

고경도용
H-CUT

고경도 리브
HR-CUT

SUS
S-CUT

센터링엔드밀
C-CUT

NC드릴
NC-DRILL

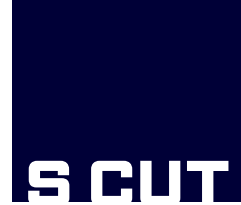

4날 스테인리스 코너R 엔드밀

4F Corner R Endmill for SUS

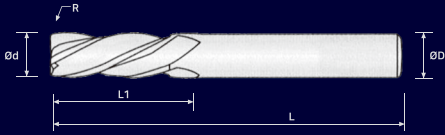
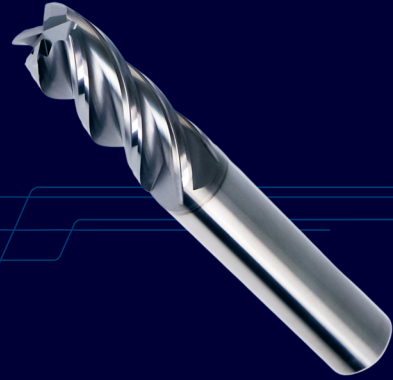

NO	CODE NO	규격 (Standard)	외경(ød)	코너(R)	날장(L1)	상크(øD)	총가장(L)
1	KW106403	Ø1*R0.1*2.5L*Ø6*50L*4F	1	R0.1	2.5	6	50
2	KW106404	Ø1*R0.2*2.5L*Ø6*50L*4F		R0.2			
3	KW106405	Ø1.2*R0.1*3L*Ø6*50L*4F	1.2	R0.1	3	6	50
4	KW106406	Ø1.5*R0.1*4L*Ø6*50L*4F	1.5	R0.1	4	6	50
5	KW106407	Ø1.5*R0.2*4L*Ø6*50L*4F		R0.2			
6	KW106408	Ø2*R0.1*6L*Ø6*50L*4F	2	R0.1	6	6	50
7	KW106409	Ø2*R0.2*6L*Ø6*50L*4F		R0.2			
8	KW106410	Ø2.5*R0.2*7L*Ø6*50L*4F	2.5	R0.2	7	6	50
9	KW106411	Ø3*R0.2*8L*Ø6*55L*4F	3	R0.2	8	6	55
10	KW106412	Ø3*R0.3*8L*Ø6*55L*4F		R0.3			
11	KW106413	Ø3*R0.5*8L*Ø6*55L*4F		R0.5			
12	KW106414	Ø4*R0.2*10L*Ø6*55L*4F	4	R0.2	10	6	55
13	KW106415	Ø4*R0.3*10L*Ø6*55L*4F		R0.3			
14	KW106416	Ø4*R0.5*10L*Ø6*55L*4F		R0.5			
15	KW106417	Ø5*R0.2*15L*Ø6*55L*4F	5	R0.2	15	6	55
16	KW106418	Ø5*R0.3*15L*Ø6*55L*4F		R0.3			
17	KW106419	Ø5*R0.5*15L*Ø6*55L*4F		R0.5			
18	KW106420	Ø6*R0.3*15L*Ø6*60L*4F	6	R0.3	15	6	60
19	KW106421	Ø6*R0.5*15L*Ø6*60L*4F		R0.5			
20	KW106422	Ø6*R1.0*15L*Ø6*60L*4F		R1.0			
21	KW106423	Ø8*R0.3*20L*Ø8*70L*4F	8	R0.3	20	8	70
22	KW106424	Ø8*R0.5*20L*Ø8*70L*4F		R0.5			
23	KW106425	Ø8*R1.0*20L*Ø8*70L*4F		R1.0			
24	KW106426	Ø10*R0.3*25L*Ø10*75L*4F	10	R0.3	25	10	75
25	KW106427	Ø10*R0.5*25L*Ø10*75L*4F		R0.5			
26	KW106428	Ø10*R1.0*25L*Ø10*75L*4F		R1.0			
27	KW106429	Ø10*R1.5*25L*Ø10*75L*4F		R1.5			
28	KW106430	Ø10*R2.0*25L*Ø10*75L*4F		R2.0			
29	KW106431	Ø10*R3.0*25L*Ø10*75L*4F	R3.0				
30	KW106432	Ø12*R0.5*30L*Ø12*80L*4F	12	R0.5	30	12	80
31	KW106433	Ø12*R1.0*30L*Ø12*80L*4F		R1.0			
32	KW106434	Ø12*R1.5*30L*Ø12*80L*4F		R1.5			
33	KW106435	Ø12*R2.0*30L*Ø12*80L*4F		R2.0			
34	KW106436	Ø12*R3.0*30L*Ø12*80L*4F		R3.0			
35	KW106437	Ø12*R4.0*30L*Ø12*80L*4F		R4.0			
36	KW106438	Ø14*R0.5*35L*Ø16*90L*4F	14	R0.5	35	16	90
37	KW106439	Ø14*R1.0*35L*Ø16*90L*4F		R1.0			
38	KW106440	Ø16*R0.5*42L*Ø16*100L*4F	16	R0.5	42	16	100
39	KW106441	Ø16*R1.0*42L*Ø16*100L*4F		R1.0			
40	KW106442	Ø20*R0.5*48L*Ø20*100L*4F	20	R0.5	48	20	100
41	KW106443	Ø20*R1.0*48L*Ø20*100L*4F		R1.0			



3-5날 스테인리스 라핑 엔드밀

3-5F Roughing Endmill for SUS

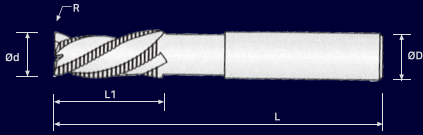

NO	CODE NO	규격 (Standard)	외경(ød)	코너(R)	날장(L1)	상크(øD)	총기장(L)	날수(F)
1	KW106511	Ø3*R0.2*8L*Ø6*50L*3F	3	R0.2	8	6	50	3
2	KW106512	Ø4*R0.2*10L*Ø6*50L*3F	4	R0.2	10	6	50	
3	KW106513	Ø5*R0.2*13L*Ø6*50L*4F	5	R0.2	13	6	50	
4	KW106514	Ø6*R0.2*13L*Ø6*60L*4F	6	R0.2	13	6	60	4
5	KW106515	Ø6*R0.5*13L*Ø6*60L*4F		R0.5				
6	KW106516	Ø7*R0.2*18L*Ø8*70L*4F	7	R0.2	18	8	70	
7	KW106517	Ø8*R0.2*19L*Ø8*70L*4F	8	R0.2	19	8	70	
8	KW106518	Ø8*R1.0*19L*Ø8*70L*4F		R1.0				
9	KW106519	Ø9*R0.3*20L*Ø10*70L*4F	9	R0.3	20	10	70	
10	KW106520	Ø10*R0.3*22L*Ø10*75L*4F	10	R0.3	22	10	75	
11	KW106521	Ø10*R1.0*22L*Ø10*75L*4F		R1.0				
12	KW106522	Ø11*R0.3*25L*Ø12*80L*4F	11	R0.3	25	12	80	
13	KW106523	Ø12*R0.3*26L*Ø12*80L*4F	12	R0.3	26	12	80	
14	KW106524	Ø12*R1.0*26L*Ø12*80L*4F		R1.0				
15	KW106525	Ø14*R0.5*28L*Ø16*90L*5F	14	R0.5	28	16	90	5
16	KW106526	Ø16*R0.5*32L*Ø16*100L*5F	16	R0.5	32	16	100	
17	KW106527	Ø16*R0.5*42L*Ø16*100L*5F			42			
18	KW106528	Ø16*R1.5*32L*Ø16*100L*5F		R1.5	32	16	100	
19	KW106529	Ø16*R1.5*42L*Ø16*100L*5F	42					
20	KW106530	Ø20*R0.5*38L*Ø20*100L*5F	20	R0.5	38	20	100	
21	KW106531	Ø20*R0.5*45L*Ø20*100L*5F			45			
22	KW106532	Ø20*R2.0*38L*Ø20*100L*5F		R2.0	38	20	100	
23	KW106533	Ø20*R2.0*45L*Ø20*100L*5F	45					

AL용
A-CUT

강용
P-CUT

강용 리브
PR-CUT

고강도용
H-CUT

고강도 리브
HR-CUT

SUS
S-CUT

센터링엔드밀
C-CUT

NC드릴
NC-DRILL